



AC-DC BATTERY CHARGER

- ▶ 120~326W *Portable Battery Charger*
- ▶ 300~1000W *Stationary Battery Charger*

DC-AC POWER INVERTER

- ▶ 500W *Stand-alone Solar Inverter*
- ▶ 100~2500W *Modified Sine Wave*
- ▶ 200~3000W *True Sine Wave*
- ▶ 1500~3000W *True Sine Wave with Solar Charger*



Total Solution For

Power Inverter & Battery Charger

About MEAN WELL

Established in 1982, MEAN WELL is a leading manufacturer of standard switching power supplies. In response to the world's energy-saving trend, we've come up with a green power solution that include DC/AC inverters, solar inverters, and battery chargers to fulfill the alternative energy requirements in the market. Those products are highly efficient, save energy, low power consumption and approved by global safety/EMC certificates per TUV, UL, and CE, which greatly guarantee your safety for all-purpose solar power applications and any charging system, such as electric scooter, electric bicycle, electric wheelchair... etc.

Backed by 31 years' experience, we have over 5,000 products that allow us to provide "one stop shopping" to our customers. Every product in the MEAN WELL range is the result of rigid procedures governing design, design verification test (DVT), design quality test (DQT), component selection, pilot-run production, and mass production. With our network of over 200 distributors in over 70 countries globally, your order can be delivered within 24 hours. No minimum order required. To source from a trusted industry supplier, contact us today!



Index

- 1 **GC/PB Series** 120~326W Portable Battery Charger
- 2 **PB Series** 300~1000W Stationary Battery Charger
ISI Series 500W Stand-alone Solar Inverter (Built-in MPPT Charger)
- 3 **A301/302 Series** 100~2500W Modified Sine Wave Inverter
- 4-5 **TS Series** 200~3000W True Sine Wave Inverter
- 6 **TN Series** 1500~3000W True Sine Wave Inverter with Solar Charger
- 7 Setting Procedure via Front Panel for TN/TS-1500/3000 Series
- 8 Comparison of UPS and Energy Saving Mode for TN Series
- 9 Applications



120~326W Portable Battery Charger

Please refer to www.meanwell.com for detail spec.

Features

- Universal AC input / Full range
- AC input range selectable by switch (PB-120)
- **No load power consumption < 0.5W (GC120)**
No load power consumption < 1W (GC160/220/330)
- High efficiency up to 94%
- Built-in active PFC function, PF>0.9 (GC series)
- Built-in passive PFC function (PB-120)
- Fully enclosed plastic case (GC series)
- 3 pole AC inlet IEC320-C14
- Class I power (with earth pin)
- **Fanless design , cooling by free air convection (GC series)**
- Cooling by built-in DC fan (PB-120/230)
- Built-in ON/OFF power switch (PB-120/230)
- Built-in remote ON/OFF control (PB-230)
- Protections:
Short circuit / Over voltage / Over temp. / Reverse polarity (PB-120/230)
- LED indicator for charging status
- **Especially suitable for portable usage**
- Charger for Lead-Acid, Li-Lon, Gel cell batteries
- 2 years warranty



CB FC CE
(GC series)

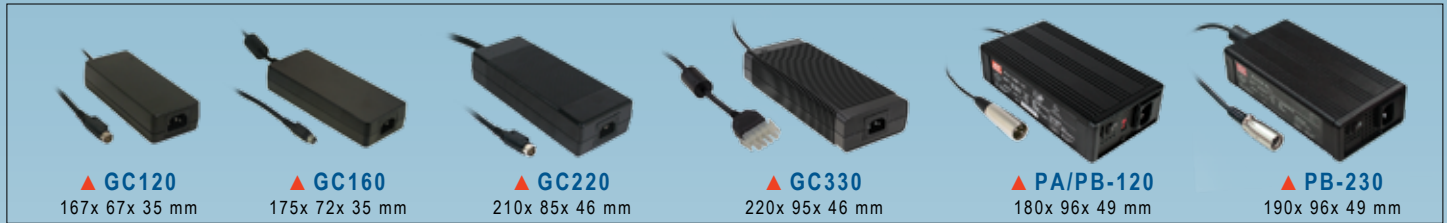
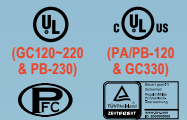

Model Name	GC120	GC160	GC220	GC330□	P□-120 =A: pulse charge B: 2 section voltage charge	PB-230
AC input voltage range	85~264VAC		90~264VAC		88~132VAC / 176~264VAC selectable by switch	90~264VAC
Charge style	2 stage				3 stage	
Over voltage protection	105%~135%, shut off O/P voltage, re-power on to recover				108%~127%, shut off output voltage, re-power on to recover (PB-230: 102%~125%)	
Withstand voltage	I/P-O/P: 3kVAC, 1 minute					
Working temperature	-30~+70°C		-30~60°C		-10~+45°C	-20~+50°C
Safety standards	GC120~220: UL1012 (AD1-Type only), EN60950-1 GC330: UL60950-1, EN60950-1				UL60950-1, TUV EN60950-1, EN60335-2-29 (except for 55.2V)	UL1012 (AD1-Type only), TUV EN60950-1
EMC standards	EN55022 class B, EN61000-4-2,3,4,5,6,8,11, EN61000-3-2,3, FCC part15 class B				EN55022 class B, EN61000-4-2,3,4,5,6,8,11, EN61000-3-2,3	
Standard DC output plug (Male, power supply side)	Power DIN 4P with lock type, Kycon KPPX-4P equivalent		4P/AMP 1-480702-0 equivalent		MIC 3P	MIC 4P

120W

Model Name	Wattage	Output	Effi.
GC120A12-□	102W	13.6V, 7.50A	86.5%
GC120A24-□	120W	27.2V, 4.42A	90.0%
GC120A48-□	120W	54.4V, 2.21A	91.0%

□ = R7B, AD1

160W

Model Name	Wattage	Output	Effi.
GC160A12-□	136W	13.6V, 10.0A	89.0%
GC160A24-□	160W	27.2V, 5.89A	92.5%
GC160A48-□	160W	54.4V, 2.95A	94.0%

□ = R7B, AD1

218W

Model Name	Wattage	Output	Effi.
GC220A12-□	184W	13.6V, 13.5A	89.0%
GC220A24-□	218W	27.2V, 8A	92.5%
GC220A48-□	218W	54.4V, 4A	93.0%

□ = R7B, AD1

326W

Model Name	Wattage	Output	Effi.
GC330A36-C4P	326W	40.8V, 8A	93.5%
GC330A48-C4P	326W	54.4V, 6A	93.5%

120W

Model Name	Wattage	Output	Effi.
P□-120-13	99W	13.8V, 0~7.2A	73.0%
P□-120-27	119W	27.6V, 0~4.3A	79.0%
P□-120-54	121W	55.2V, 0~2.2A	79.0%

230W

Model Name	Wattage	Output	Effi.
PB-230-12□	230W	14.4V, 0~16A	81.5%
PB-230-24□	230W	28.8V, 0~8A	85.5%
PB-230-48□	230W	57.6V, 0~4A	86.0%

□ = Blank, AD1 ; Blank: Power DIN 4P, AD1: Anderson Connector

Model Name	Output Connector	Safety
GC120A△-R7B GC160A△-R7B GC220A△-R7B PB-230-△	Power DIN 4P	CB FC CE (GC series only)
GC120A△-AD1 GC160A△-AD1 GC220A△-AD1 PB-230-△AD1	Anderson Connector	UL CB FC CE (GC series only)
GC330A○-C4P	AMP Connector	UL US CB FC CE

- UL1012 listed only for "Anderson Connector"
- △ = 12,24,48 ; R7B: Power DIN 4P, AD1: Anderson Connector
- ○ = 36,48 ; C4P: AMP 1-480702-0 equivalent

300~1000W

Stationary Battery Charger

Features

- Universal AC input / Full range (PB-600/1000)
- AC input range selectable by switch (PB-300/360)
- Built-in passive PFC function (PB-300P/360P)
- Built-in active PFC function (PB-600/1000)
- 3 poles AC inlet IEC320-C14
- Cooling by built-in DC fan (except for PB-300)
- Built-in ON/OFF power switch
- Built-in remote ON/OFF control
- 2/3/8 stage smart charger for PB-600/1000
- Protections:
 - Short circuit / Over voltage / Over temperature / Reverse polarity
- LED indicator for charging status
- 3 years warranty

Please refer to www.meanwell.com for detail spec.

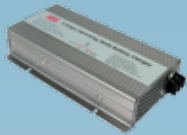

▲ PB-300 253x 135x 48.5 mm

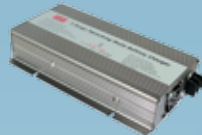

▲ PB-360 253x 135x 48.5 mm



▲ PB-600 230x 158x 67 mm



▲ PB-1000 300x 184x 70 mm

Model Name	PB-300	PB-360	PB-600	PB-1000
AC input voltage range	90~132VAC / 180~264VAC selectable by switch		90~264VAC	
Charge style	3 stage		2/3/8 stage (selectable)	
Over voltage protection	Range	108%~125%	112%~125%	
	Type	shut off output voltage, re-power on to recover		
Withstand voltage	I/P-O/P: 3kVAC, 1 minute			
Working temperature	-10~+50°C		-20~+60°C	
Safety standards	PB-300/360: UL60950-1, CB IEC60335-2-29 (except for 48V)			
	PB-600: UL1012, TUV EN60950-1 (48V only), TUV EN60335-2-29 (except for 48V)			
	PB-1000: UL60950-1, TUV EN60950-1			
EMC standards	EN55022 class B, EN61000-4-2,3,4,5,6,8,11, EN61000-3-2,3 (except for PB-300N/360N)			
DC output connector	Terminal block 2P			Terminal block 3P

300W

Model Name	Wattage	Output	Effi.
PB-300□-12	300W	14.4V, 0~20.85A	85%
PB-300□-24	302W	28.8V, 0~10.5A	86%
PB-300□-48	305W	57.6V, 0~5.3A	88%

□ = P, N ; P: with PFC, N: non PFC

600W

Model Name	Wattage	Output	Effi.
PB-600-12	576W	14.4V, 0~40.0A	86%
PB-600-24	605W	28.8V, 0~21.0A	87%
PB-600-48	605W	57.6V, 0~10.5A	89%

360W

Model Name	Wattage	Output	Effi.
PB-360□-12	350W	14.4V, 0~24.3A	85%
PB-360□-24	360W	28.8V, 0~12.5A	86%
PB-360□-48	360W	57.6V, 0~6.25A	87%

□ = P, N ; P: with PFC, N: non PFC

1000W

Model Name	Wattage	Output	Effi.
PB-1000-12	864W	14.4V, 0~60.0A	85%
PB-1000-24	999W	28.8V, 0~34.7A	88%
PB-1000-48	1002W	57.6V, 0~17.4A	89%

500W DC/AC Off-Grid Solar Inverter



Features

- True sine wave output (THD<3%)
- Built-in 500W MPPT solar charger, MPPT efficiency: 98% (Peak)
- High surge power up to 1000W
- Output voltage / Frequency adjustable
- High efficiency up to 88%
- Front panel indicator for operation status
- Protections:
 - Input: Bat. low alarm / Bat. low shutdown / Reverse polarity / Over voltage
 - Output: Short circuit / Overload / Over temperature
- 3 years warranty

Please refer to www.meanwell.com for detail spec.



205x 158x 67 mm



FCC/CE pending

Output power	500W (rated power); 1000W (surge power)	
DC input rated voltage	12VDC, 24VDC or 48VDC	
AC output voltage	100/110/115/120VAC; 200/220/230/240VAC adjustable via setting button on front panel	
Output frequency	50Hz/60Hz adjustable via setting button on front panel	
AC output waveform	True sine wave, THD<3.0%	
AC output regulation	±3% of rated output voltage	
No load dissipation (Typ.)	≤15W	
Working temperature	-20~+60°C (refer to output derating curve)	
	Input voltage range	25~50V, 35~90V or 70~160V
	Max. short circuit current	11A (4.5A for 48VDC input)
Solar Panel	Rated charger power	500W
Safety standards	EN60950-1(LVD)	
EMC standards	FCC part 15 class B,	
	EN55022 class B, EN61000-4-2,3,8	

Model Name	Continue Power	Input VDC	Output VAC/Hz	Output socket	Effi.
ISI-501-112□	450W	10.5~15	110/60	TYPE-A	85%
ISI-501-124□	500W	21~30	110/60	TYPE-A	87%
ISI-501-148□	500W	42~60	110/60	TYPE-A	87%
ISI-501-212□	450W	10.5~15	230/50	TYPE-B	86%
ISI-501-224□	500W	21~30	230/50	TYPE-B	88%
ISI-501-248□	500W	42~60	230/50	TYPE-B	88%

□ = A, B (standard model), C, D, E, F, U (optional model)

▶ Please refer to Page 4 for AC output receptacle list

100~2500W Modified Sine Wave



Please refer to www.meanwell.com for detail spec.

Features

- High frequency design
- Input protections:
Reverse polarity / Over and under voltage / Battery low alarm and shutdown
- Output protections: Short circuit / Overload / Over temp.
- With power ON/OFF switch and LED indicator
- Built-in remote ON/OFF control for 1000~2500W (optional)
- **Built-in USB interface and without fan for 100W**
- Input and output fully isolation
- Low power consumption (standby)
- LVD meet EN60950-1 and e13 mark
- EMC meet EN61000-4-2,3, EN55022
- 1 year warranty

e13 CE



AC Output Receptacle (optional) for A301/A302 Series

TYPE-1	TYPE-2	TYPE-3	TYPE-4	TYPE-5	TYPE-6
JAPAN	USA	EUROPE	UNIVERSAL	AUSTRALIA	U.K.

▶ Please consult MeanWell for other kinds of optional socket.
TYPE-2,3 (standard model) ; TYPE-1,4,5,6 (optional model)



Model Name	A301	A302
DC input rated voltage	12.5VDC	25.0VDC
AC output voltage / Frequency	110VAC(rms) / 60Hz or 230VAC(rms) / 50Hz	
Max. output power	100W, 150W, 300W, 600W, 1000W, 1500W, 2500W	
USB output power	5VDC / 500mA (100W only)	
AC output regulation	±10% of rated output voltage	
Bat. low alarm	10±0.5VDC	20.5±1.0VDC
Bat. low shut down	9.5±0.5VDC	19.5±1.0VDC
I/P over voltage protection	15~17VDC	30~32VDC
Working temperature	0~+40°C (0~+25°C for 2500W)	
Safety standards	Compliance to EN60950-1(LVD)	
EMC standards	Compliance to EN55022 class B, e-mark, EN61000-4-2,3	

100W					
Model Name	Continue power	Input VDC	Output VAC / Hz	Output socket	Effi.
A301-100-F3	100W	10-15	230 / 50	TYPE-3	90%
A302-100-F3	100W	21-30	230 / 50	TYPE-3	90%

150W					
Model Name	Continue power	Input VDC	Output VAC / Hz	Output socket	Effi.
A301-150-B2	150W	10-15	110 / 60	TYPE-2	78%
A301-150-F3	150W	10-15	230 / 50	TYPE-3	78%
A302-150-B2	150W	21-30	110 / 60	TYPE-2	82%
A302-150-F3	150W	21-30	230 / 50	TYPE-3	82%

300W					
Model Name	Continue power	Input VDC	Output VAC / Hz	Output socket	Effi.
A301-300-B2	300W	10-15	110 / 60	TYPE-2	82%
A301-300-F3	300W	10-15	230 / 50	TYPE-3	82%
A302-300-B2	300W	21-30	110 / 60	TYPE-2	85%
A302-300-F3	300W	21-30	230 / 50	TYPE-3	85%

600W					
Model Name	Continue power	Input VDC	Output VAC / Hz	Output socket	Effi.
A301-600-B2	600W	10-15	110 / 60	TYPE-2	82%
A301-600-F3	600W	10-15	230 / 50	TYPE-3	82%
A302-600-B2	600W	21-30	110 / 60	TYPE-2	85%
A302-600-F3	600W	21-30	230 / 50	TYPE-3	85%

1000W					
Model Name	Continue power	Input VDC	Output VAC / Hz	Output socket	Effi.
A301-1K0-B2	1000W	10-15	110 / 60	TYPE-2	82%
A301-1K0-F3	1000W	10-15	230 / 50	TYPE-3	82%
A302-1K0-B2	1000W	21-30	110 / 60	TYPE-2	85%
A302-1K0-F3	1000W	21-30	230 / 50	TYPE-3	85%

1500W					
Model Name	Continue power	Input VDC	Output VAC / Hz	Output socket	Effi.
A301-1K7-B2	1500W	10-15	110 / 60	TYPE-2	82%
A301-1K7-F3	1500W	10-15	230 / 50	TYPE-3	82%
A302-1K7-B2	1500W	21-30	110 / 60	TYPE-2	85%
A302-1K7-F3	1500W	21-30	230 / 50	TYPE-3	85%

2500W					
Model Name	Continue power	Input VDC	Output VAC / Hz	Output socket	Effi.
A301-2K5-B4	2500W	10-15	110 / 60	TYPE-2	82%
A301-2K5-F3	2500W	10-15	230 / 50	TYPE-3	82%
A302-2K5-B4	2500W	21-30	110 / 60	TYPE-2	85%
A302-2K5-F3	2500W	21-30	230 / 50	TYPE-3	85%

200~700W True Sine Wave



Features

- True sine wave output (THD<3%)
- 2 times high surge power for motor related application
- Advanced digital control by microprocessor
- Output voltage / frequency adjustable
- High efficiency up to 91%
- Conformal coating for TS-700
- Standby saving mode to conserve energy (TS-700)
- Built-in fan ON/OFF control function (TS-400/700)
- Fanless design, cooling by free air convection (TS-200)
- Front panel indicator for load / battery / operation status

- High frequency design
- Input protections:
Bat. low alarm / Bat. low shutdown / Reverse polarity / Over voltage
- Output protections:
Short circuit / Overload / Over temperature
- Applications:
Home appliance, power tools, office and portable equipment, vehicle and yacht...etc.
- 3 years warranty



Please refer to www.meanwell.com for detail spec.

TS-200	TS-400	TS-700
		
205x 158x 59 mm	205x 158x 67 mm	295x 184x 70 mm

Rated output power	200W	400W	700W
Maximum output power	230W for 3 minutes; 300W for 10 sec.	460W for 3 minutes; 600W for 10 sec.	800W for 3 minutes; 1050W for 10 sec.
Output surge rating (30 cycles)	400W	800W	1400W
DC input rated voltage	12VDC, 24VDC or 48VDC		
AC output voltage	100 / 110 / 115 / 120VAC; 200 / 220 / 230 / 240VAC adjustable via setting button on front panel		
Output frequency	50Hz / 60Hz adjustable via setting button on front panel		
AC output waveform	True sine wave, THD<3.0%		
AC output regulation (Typ.)	±3% of rated output voltage		
No load dissipation (Typ.)	≤15W	≤6W@standby saving mode	
Working temperature	-10~+60°C		0~+60°C
Safety standards	110V	Design refer to UL458	
	230V	Compliance to EN60950-1(LVD)	
EMC standards	110V	Compliance to FCC part 15 class A	
	230V	Compliance to EN55022 class A, E-Mark, EN61000-4-2,3,8	

200W

Model Name	Continue power	Input VDC	Output VAC / Hz	Output socket	Effi.
TS-200-112[A]	200W	10.5-15	110 / 60	TYPE-A	86.0%
TS-200-124[A]	200W	21.0-30	110 / 60	TYPE-A	87.5%
TS-200-148[A]	200W	42.0-60	110 / 60	TYPE-A	88.0%
TS-200-212[B]	200W	10.5-15	230 / 50	TYPE-B	86.0%
TS-200-224[B]	200W	21.0-30	230 / 50	TYPE-B	87.5%
TS-200-248[B]	200W	42.0-60	230 / 50	TYPE-B	88.0%

400W



Model Name	Continue power	Input VDC	Output VAC / Hz	Output socket	Effi.
TS-400-112[A]	400W	10.5-15	110 / 60	TYPE-A	84.5%
TS-400-124[A]	400W	21.0-30	110 / 60	TYPE-A	86.0%
TS-400-148[A]	400W	42.0-60	110 / 60	TYPE-A	87.0%
TS-400-212[B]	400W	10.5-15	230 / 50	TYPE-B	86.0%
TS-400-224[B]	400W	21.0-30	230 / 50	TYPE-B	87.5%
TS-400-248[B]	400W	42.0-60	230 / 50	TYPE-B	88.5%

700W

Model Name	Continue power	Input VDC	Output VAC / Hz	Output socket	Effi.
TS-700-112[A]	700W	10.5-15	110 / 60	TYPE-A	86%
TS-700-124[A]	700W	21.0-30	110 / 60	TYPE-A	88%
TS-700-148[A]	700W	42.0-60	110 / 60	TYPE-A	89%
TS-700-212[B]	700W	10.5-15	230 / 50	TYPE-B	89%
TS-700-224[B]	700W	21.0-30	230 / 50	TYPE-B	90%
TS-700-248[B]	700W	42.0-60	230 / 50	TYPE-B	91%

□ = A, B (standard model), C, D, E, F (optional model)

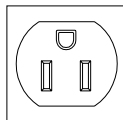
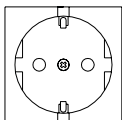
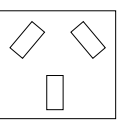
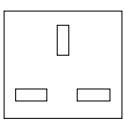
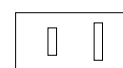
AC Output Receptacle List

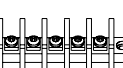
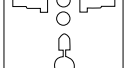
TYPE-A	TYPE-B	TYPE-C	TYPE-D
			
USA	Europe	Australia	U.K.
TYPE-E	TYPE-F	TYPE-G	TYPE-U
		 (Terminal only)	
Japan	GFCI	-----	Universal

▶ Please consult MEAN WELL for other kinds of optional output socket.



1000~3000W



True Sine Wave

Please refer to www.meanwell.com for detail spec.

Features

- True sine wave output (THD<3%)
- **2 times high surge power for motor related application**
- Advanced digital control by microprocessor
- High efficiency up to 92%
- **Conformal coating**
- Standby saving mode to conserve energy
- Built-in fan ON/OFF control function
- Output voltage / frequency adjustable
- Front panel indicator for load / battery / operation status

- High frequency design
- Input protections:
Bat. low alarm / Bat. low shutdown / Reverse polarity / Over voltage
- Output protections:
Short circuit / Overload / Over temperature
- Applications:
Home appliance, power tools, office and portable equipment, vehicle and yacht...etc.
- 3 years warranty



TS-1000



345x 184x 70 mm

TS-1500



420x 220x 88 mm

TS-3000



466.8x 283.5x 100 mm

Rated output power	1000W	1500W	3000W
Maximum output power	1150W for 3 minutes; 1500W for 10 sec.	1725W for 3 minutes ; 2250W for 10 sec.	3450W for 3 minutes ; 4500W for 10 sec.
Output surge rating (30 cycles)	2000W	3000W	6000W
DC input rated voltage	12VDC, 24VDC or 48VDC		
AC output voltage	100 / 110 / 115 / 120VAC or 200 / 220 / 230 / 240VAC adjustable via setting button on front panel		
Output frequency	50Hz/60Hz adjustable via setting button on front panel		
AC output waveform	True sine wave, THD<3.0%		
AC output regulation (Typ.)	±3% of rated output voltage		
No load dissipation (Typ.)	≤ 6W @ standby saving mode	≤ 18W @ standby saving mode	≤ 10W @ standby saving mode
Working temperature	0~+60°C		
Safety standards	110V	UL458 approved (except for 48V and only for GFCI receptacle)	UL458 approved for TYPE-G
	230V	Compliance to EN60950-1 (LVD)	
EMC standards	110V	Compliance to FCC part 15 class A	
	230V	Compliance to EN55022 class A (class B for TS-1500), E-Mark, EN61000-4-2,3,8	

1000W

Model Name	Continue power	Input VDC	Output VAC / Hz	Output socket	Effi.
TS-1000-112[A]	1000W	10.5-15	110 / 60	TYPE-A	88%
TS-1000-124[A]	1000W	21.0-30	110 / 60	TYPE-A	89%
TS-1000-148[A]	1000W	42.0-60	110 / 60	TYPE-A	90%
TS-1000-212[B]	1000W	10.5-15	230 / 50	TYPE-B	90%
TS-1000-224[B]	1000W	21.0-30	230 / 50	TYPE-B	91%
TS-1000-248[B]	1000W	42.0-60	230 / 50	TYPE-B	92%

1500W

Model Name	Continue power	Input VDC	Output VAC / Hz	Output socket	Effi.
TS-1500-112[A]	1500W	10.5-15	110 / 60	TYPE-A	87%
TS-1500-124[A]	1500W	21.0-30	110 / 60	TYPE-A	89%
TS-1500-148[A]	1500W	42.0-60	110 / 60	TYPE-A	89%
TS-1500-212[B]	1500W	10.5-15	230 / 50	TYPE-B	88%
TS-1500-224[B]	1500W	21.0-30	230 / 50	TYPE-B	90%
TS-1500-248[B]	1500W	42.0-60	230 / 50	TYPE-B	91%

3000W

Model Name	Continue power	Input VDC	Output VAC / Hz	Output socket	Effi.
TS-3000-112[A]	3000W	10.5-15	110 / 60	TYPE-A	88%
TS-3000-124[A]	3000W	21.0-30	110 / 60	TYPE-A	90%
TS-3000-148[A]	3000W	42.0-60	110 / 60	TYPE-A	91%
TS-3000-212[B]	3000W	10.5-15	230 / 50	TYPE-B	89%
TS-3000-224[B]	3000W	21.0-30	230 / 50	TYPE-B	91%
TS-3000-248[B]	3000W	42.0-60	230 / 50	TYPE-B	92%

□ = A, B (standard model), C, D, E, F (optional model), G (optional model for TS-3000 only)

► Please refer to page 4 for AC output receptacle list.

► Inverter Remote Controller

IRC series is the monitoring and control unit used for the inverter series. It can decode the RS-232 signal sent by inverter series and display through digital meters.



75x 55x 21mm

Features:

- Wall-mounted and control panel assembly acceptable
- Built-in ON/OFF button
- LED indicators for remote ON/OFF, abnormal and power saving mode
- Equipped with 10FT cable, optional for 25FT or 50FT
- Connect directly to the remote socket of inverter; no power supply needed
- Suitable series:
 - IRC1:** TS-700 / 1000 / 1500 / 3000 TN-1500 / 3000
 - IRC2:** TS-700 / 1000 / 1500 / 3000
 - IRC3:** TN-1500 / 3000
- 3 years warranty

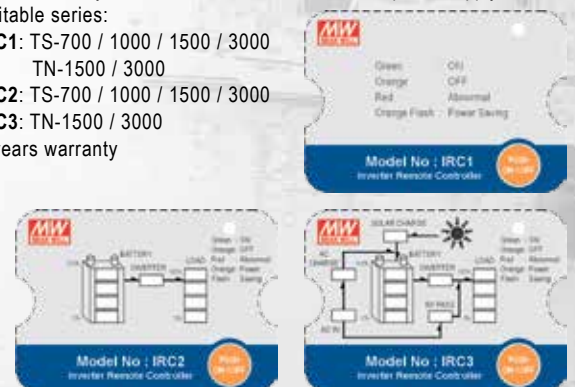

1500~3000W



True Sine Wave with Solar Charger

Features

- True sine wave output (THD<3%)
- **2 times high surge power for motor related application**
- Advanced digital control by microprocessor
- High frequency design; high efficiency up to 92%
- **Conformal coating**
- Standby saving mode to conserve energy
- Built-in fan ON/OFF control function
- Output voltage / frequency adjustable
- Input protections: Bat. low alarm / Bat. low shutdown / Reverse polarity / Over voltage

- Solar input current up to 30A max.
- Output protections: Short circuit / Overload / Over temperature / AC circuit breaker
- Front panel indicator for load / battery / operation status
- **Selectable UPS & energy saving mode**
- **AC by pass / Built-in AC and solar charger**
- Fast transfer time under 10ms (Inverter mode ⇌ Bypass mode)
- **Optional monitoring software and connection cable (MW order No.: DS-TN-1500 for TN-1500/3000)**



Please refer to www.meanwell.com for detail spec.

TN-1500



420x 220x 88 mm

TN-3000



466.8x 283.5x 100 mm

Rated output power	1500W	3000W
Maximum output power	1725W for 3 minutes ; 2250W for 10 seconds	3450W for 3 minutes ; 4500W for 10 seconds
Output surge rating (30 cycles)	3000W	6000W
DC input rated voltage	12VDC, 24VDC or 48VDC	
AC output voltage	100 / 110 / 115 / 120VAC or 200 / 220 / 230 / 240VAC adjustable via front panel or monitoring software	
AC output regulation (Typ.)	±3% of rated output voltage	
No load dissipation (Typ.)	≤18W @ standby saving mode	≤10W @ standby saving mode
Output frequency	50Hz/60Hz adjustable via front panel or monitoring software	
AC output waveform	True sine wave, THD<3.0%	
Transfer time (Typ.)	10ms; inverter mode ⇌ Bypass mode	
Working temperature	0~+60°C	
Safety standards	110V	UL458 approved (except for 48V and only for GFCI receptacle)
	230V	Compliance to EN60950-1 (LVD)
EMC standards	110V	Compliance to FCC part 15 class A
	230V	Compliance to EN55022 class A (class B for TN-1500), E-Mark, EN61000-4-2,3,4,5,6,8,11

Solar Inverter Block Diagram (Inverter with AC & Solar Charger) - TN Series

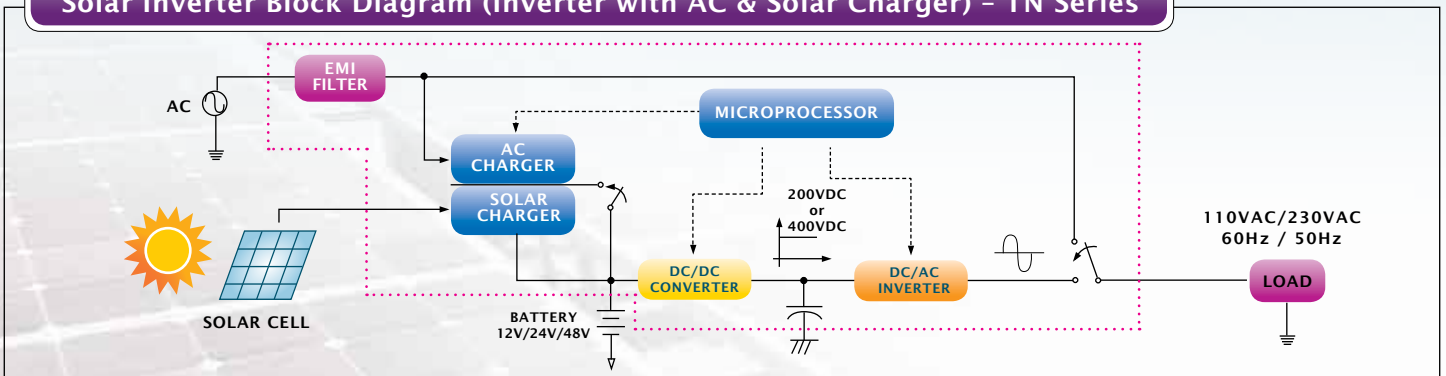

1500W

Model Name	Continue power	Input VDC	Output VAC / Hz	Output socket	Effi.
TN-1500-112[A]	1500W	10.5-15	110 / 60	TYPE-A	87%
TN-1500-124[A]	1500W	21.0-30	110 / 60	TYPE-A	89%
TN-1500-148[A]	1500W	42.0-60	110 / 60	TYPE-A	89%
TN-1500-212[B]	1500W	10.5-15	230 / 50	TYPE-B	88%
TN-1500-224[B]	1500W	21.0-30	230 / 50	TYPE-B	90%
TN-1500-248[B]	1500W	42.0-60	230 / 50	TYPE-B	91%

3000W

Model Name	Continue power	Input VDC	Output VAC / Hz	Output socket	Effi.
TN-3000-112[A]	3000W	10.5-15	110 / 60	TYPE-A	88%
TN-3000-124[A]	3000W	21.0-30	110 / 60	TYPE-A	90%
TN-3000-148[A]	3000W	42.0-60	110 / 60	TYPE-A	91%
TN-3000-212[B]	3000W	10.5-15	230 / 50	TYPE-B	89%
TN-3000-224[B]	3000W	21.0-30	230 / 50	TYPE-B	91%
TN-3000-248[B]	3000W	42.0-60	230 / 50	TYPE-B	92%

□ = A, B (standard model), C, D, E, F (optional model), G (optional model for TN-3000 only)
 ▶ Please refer to page 4 for AC output receptacle list.

Setting Procedure via Front Panel

for TS/TN-1500/3000 Series



Front Panel

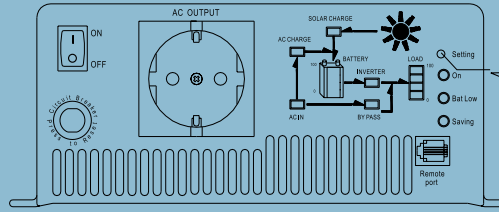

Use an insulated stick to press this setting button

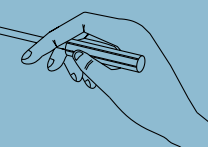

Function

Setting Procedure

First Level	UPS and Energy Saving Mode Selection	<p>Step 1 The inverter should be turned off while resetting, input batteries should be connected. AC main can either be connected or disconnected, and the load should be removed.</p> <p>Step 2 Use an insulated stick to press the setting button and then turn on the power switch. After pressing for 5 seconds, the inverter will send out a "Beep" sound. User can release the button and go into the setting procedure.</p> <p>Step 3 Please refer to table below and check the LED status to see if the operating mode is the one you need. (Factory setting: UPS mode)</p> <table border="1"> <thead> <tr> <th>Mode</th> <th>UPS Mode</th> <th>Energy Saving Mode</th> </tr> </thead> <tbody> <tr> <td>LED Status</td> <td></td> <td></td> </tr> <tr> <td>On</td> <td>○</td> <td>●</td> </tr> <tr> <td>Bat Low</td> <td>✱</td> <td>✱</td> </tr> <tr> <td>Saving</td> <td>✱</td> <td>✱</td> </tr> </tbody> </table> <p>● Light ○ Dark ✱ Flashing</p> <p>Step 4 The LED will change state by pressing the setting button for 1 second and then release.</p>	Mode	UPS Mode	Energy Saving Mode	LED Status			On	○	●	Bat Low	✱	✱	Saving	✱	✱																					
	Mode	UPS Mode	Energy Saving Mode																																			
LED Status																																						
On	○	●																																				
Bat Low	✱	✱																																				
Saving	✱	✱																																				
Second Level	Output Voltage and Frequency Adjustment	<p>Step 1 After selecting the operating mode, pressing the setting button for 3~5 seconds and the inverter will send out a "Beep" sound. The button can be released and you can go on to the second section of "voltage / frequency".</p> <p>Step 2 Please refer to table below and check the LED status to see if the output voltage / frequency is the one you need (Factory setting: 230VAC/50Hz or 110VAC / 60Hz)</p> <table border="1"> <thead> <tr> <th>Mode</th> <th>100VAC (200VAC)</th> <th>110VAC (220VAC)</th> <th>115VAC (230VAC)</th> <th>120VAC (240VAC)</th> </tr> </thead> <tbody> <tr> <td>LED Status</td> <td></td> <td></td> <td></td> <td></td> </tr> <tr> <td rowspan="3">50Hz</td> <td>On</td> <td>●</td> <td>●</td> <td>●</td> </tr> <tr> <td>Bat Low</td> <td>○</td> <td>○</td> <td>●</td> </tr> <tr> <td>Saving</td> <td>○</td> <td>●</td> <td>○</td> </tr> <tr> <td rowspan="3">60Hz</td> <td>On</td> <td>✱</td> <td>✱</td> <td>✱</td> </tr> <tr> <td>Bat Low</td> <td>○</td> <td>○</td> <td>●</td> </tr> <tr> <td>Saving</td> <td>○</td> <td>●</td> <td>○</td> </tr> </tbody> </table> <p>● Light ○ Dark ✱ Flashing</p> <p>Step 3 The LED will change state by pressing the setting button for 1 second and then release.</p>	Mode	100VAC (200VAC)	110VAC (220VAC)	115VAC (230VAC)	120VAC (240VAC)	LED Status					50Hz	On	●	●	●	Bat Low	○	○	●	Saving	○	●	○	60Hz	On	✱	✱	✱	Bat Low	○	○	●	Saving	○	●	○
Mode	100VAC (200VAC)	110VAC (220VAC)	115VAC (230VAC)	120VAC (240VAC)																																		
LED Status																																						
50Hz	On	●	●	●																																		
	Bat Low	○	○	●																																		
	Saving	○	●	○																																		
60Hz	On	✱	✱	✱																																		
	Bat Low	○	○	●																																		
	Saving	○	●	○																																		
Third Level	Saving Mode Selection	<p>Step 1 After selecting the output voltage and frequency, press the setting button for 5 seconds and the inverter will send out a "Beep" sound. The button can be released and you can go into the setting section for "saving mode".</p> <p>Step 2 Please refer to table below and check the LED status. (Factory setting: saving mode OFF)</p> <table border="1"> <thead> <tr> <th>Mode</th> <th>ON</th> <th>OFF</th> </tr> </thead> <tbody> <tr> <td>LED Status</td> <td></td> <td></td> </tr> <tr> <td>On</td> <td>✱</td> <td>✱</td> </tr> <tr> <td>Bat Low</td> <td>✱</td> <td>✱</td> </tr> <tr> <td>Saving</td> <td>●</td> <td>○</td> </tr> </tbody> </table> <p>● Light ○ Dark ✱ Flashing</p> <p>Step 3 The LED will change state by pressing the setting button for 1 second and then release.</p> <p>Step 4 Press the setting button for 5 seconds and the inverter will send out a "Beep" sound, the button can be released and all the setting are finished. The inverter will automatically store all the setting and then start to operate.</p>	Mode	ON	OFF	LED Status			On	✱	✱	Bat Low	✱	✱	Saving	●	○																					
Mode	ON	OFF																																				
LED Status																																						
On	✱	✱																																				
Bat Low	✱	✱																																				
Saving	●	○																																				

Note: 1.Descriptions which are highlighted represent functions exclusive to the TN-1500/3000 series.
2.For setting procedure of other product series, please refer to <http://www.meanwell.com/product/inverter/inverter01.html>

Comparison of UPS and Energy Saving Mode

UPS and Energy Saving Block Diagram

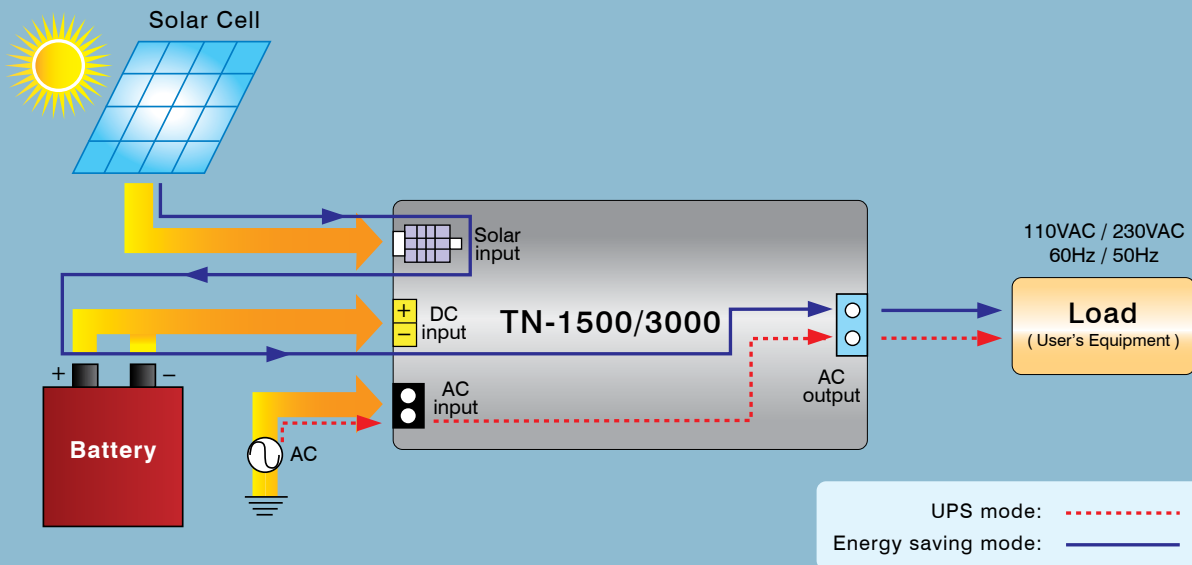

Operation Mode	Description & Special Feature	Possible Application
UPS mode	<p>Utility has the highest priority, the TN unit will operate as an UPS system.</p> <p>Utility $\xrightarrow{\text{bypass}}$ load (user's equipment)</p> <p>Utility $\xrightarrow{\text{back-up}}$ battery bank \rightarrow Inverter \rightarrow load (user's equipment)</p> <ul style="list-style-type: none"> • Area with unstable utility • Better performance as compared to conventional UPS (capable of withstanding heavy load) 	<ul style="list-style-type: none"> • Office: computer system, security system, printer, scanner, fax...etc. • Home: personal computer, refrigerator, lighting...etc. • Telecom sub-station
Energy Saving mode	<p>Solar energy has the highest priority. Utility bill can be reduced since the TN unit acquires energy from the solar panel as higher priority.</p> <p>Solar panel \rightarrow battery bank \rightarrow inverter \rightarrow load (user's equipment)</p> <ul style="list-style-type: none"> • With additional solar panel. It can be used as individual sub power station (Independent power station) • Area without utility or unstable utility • Cut cost on utility bill 	<ul style="list-style-type: none"> • High altitude location or green building: weather station, lighting, hair dryer...etc. • Yacht: TV, DVD, radio, air conditioner, coffee maker...etc. • Vehicle: mobile phone charger, notebook, electronic pot...etc.

Notice

- **Modified sine wave inverter** is a stepped waveform that is designed to have characteristics similar to the sine wave shape of utility power. It is suitable for most household applications, such as notebook, PC, MP3 player, cell phone charger, and digital camera...etc. but may present certain compromises with some loads such as ham radio, microwave oven(with clock), laser printer, motor speed controller, transformer-less charger, and load with high surge demand (capacitance, fluorescent lamp...etc.).
- **True sine wave inverter** is suitable for most AC loads, including all electronic equipment of household, motor related application such as electronic drill, linear and switching power supply used in electronic equipment.

Applications



- 1 Solar Panel
- 2 Battery Bank
- 3 Off-Grid DC/AC Solar Inverter (TN Series)
- 4 AC Input (bypass)
- 5 AC Outlet

- 1 Utility Input (Shore)
- 2 AC/DC Battery Charger (PB series)
- 3 Battery Bank
- 4 Off-Grid AC/DC Power Inverter (TS series)
- 5 AC Outlet

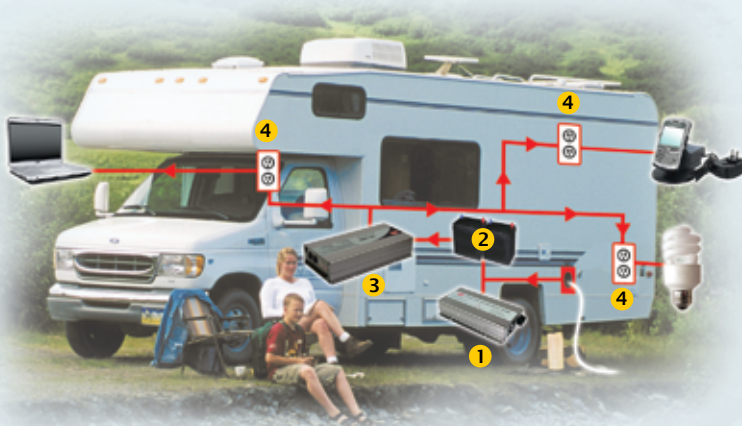

- 1 AC/DC Battery Charger (PB series)
- 2 Battery Bank
- 3 Off-Grid DC/AC Inverter (TS series)
- 4 AC Outlet

Applications:

TV, DVD, notebook, personal computer, lighting, refrigerator, fan, radio, hair dryer, electronic pot, coffee maker, and cell phone charger...etc.



Taiwan

明緯企業股份有限公司 **MEAN WELL ENTERPRISES CO., LTD.**

新北市五股區五權三路28號

No. 28, Wuquan 3rd Road, Wugu District, New Taipei City, Taiwan, 24891

Tel +886-2-2299-6100(rep.)

Fax +886-2-2299-6200(rep.) +886-2-2298-0818(sales)

E-mail info@meanwell.com **Web** www.meanwell.com

China

明緯(廣州)電子有限公司 **MEAN WELL (GUANGZHOU) ELECTRONICS CO., LTD.**

廣州市天河區東圃鎮黃村粵安工業園A棟2樓

2F, A Building, Yuean Industry Park, Huangcun,

Dongpu Town, Tianhe District, Guangzhou, China

Tel +86-20-2887-1200

Fax +86-20-8201-0507

E-mail info@meanwell.com.cn **Web** www.meanwell.com.cn

China

蘇州明緯科技有限公司 **SUZHOU MEAN WELL TECHNOLOGY CO., LTD.**

江蘇省蘇州市相城區黃埭鎮潘陽工業園東橋健民路77號

No.77, Jian-Ming Rd. Dong-Qiao, Pan-Yang Ind. Park, Huang-Dai Town,

Xiang-Cheng District, SuZhou, Jiang-Su, China

Tel +86-512-6508-8600 **Fax** +86-512-6508-8700

E-mail info@meanwell.cc **Web** www.meanwell.cc

U.S.A.

MEAN WELL USA, INC.

44030 Fremont Blvd., Fremont, CA 94538, U.S.A.

Tel +1-510-683-8886

Fax +1-510-683-8899

E-mail info@meanwellusa.com **Web** www.meanwellusa.com

Europe

MEAN WELL EUROPE B.V.

Langs de Werf 8, 1185XT Amstelveen, the Netherlands

Tel +31-20-758-6000

Fax +31-20-758-6001

E-mail info@meanwell.eu **Web** www.meanwell.eu

Please contact your local distributor:



For more information, please visit:

www.meanwell.com

January 2014